X-ray Security Inspection Equipment

MCD-5030C

The User Manual

Preface

Giving a security check for the passengers luggage in important passageway (such as airport, port, station, customs etc.) has become the welcome security measures internationally since 1970s. From 1980s, with the development of economy and the increase of people's living standards, working outside, sightseeing, study & communication are becoming more and more popular. To ensure the safety of passenger during the journey, traffic ports around the country start to forbid passengers carrying dangerous articles that are flammable and explosive on the vehicle. In the recent years, many conflicts become acute in the world, such as unequal status of country, serious polarization between the bourgeoisie and the proletariat, hegemonism, and nationalism movement after the cold war, which result in all kinds of frequent terrorist attacks around the world. In order to achieve their goals and enlarge the influence, some terrorists attack the airplanes and cars, causing great property loss and death. If dangerous articles in luggage are detected before getting on the vehicle, such incident may be avoided. Therefore, how to check the passengers luggage in a simple and effective way is becoming very important for the safety of visitors and their properties.

X-ray security inspection equipment is universally used nowadays in all kinds of security checks. Our X-ray security inspection equipment model MCD-5030C, take advantage of the X-ray penetration capability to realize the quick check for the luggage and articles without unpacking.

MCD-5030C X-ray security Inspection Equipment is an advanced X-ray image detecting system. The system integrates the advantages of high-performance semiconductor detector, digital image processing technology, and computer image display, and provides users with reliable quality images. You can store as many high-resolution images as you like depending on the HD capacity. With reliable auto-alarm for dangerous articles and automatic error detection & maintenance, as well as the simple and personalized design of operation, the users can operate it more conveniently.

Because MCD-5030C X-ray security inspection equipment demands low dose of X-ray in a check, and the X-ray leakage is less than $0.1\mu\text{Gy/h}$, far lower than the international standard $5\mu\text{Gy/h}$, which is safe. Therefore, the device is safe to the operators, passengers and their commercial film.

The user manual contains the important information for safety use of MCD-5030C X-ray security inspection equipment. Read the user manual provided by the manufacturer carefully before using the device.

The update speed cannot follow that of the software, if there is difference with the present version, please understand.

Only persons passed the train of radiation safety and system operation can operate the MCD-5030C X-ray security inspection equipment.

Notice: To avoid the radiation, please abide by the rules for radiation safety in any time.

Contents

Chapter I System Overview	1
1.1 Working Principle.....	1
1.2 Special Features and Technical Data.....	1
1.3 Elements of Model and Their Meanings.....	3
1.4 Main Purpose and Applications.....	3
Chapter II Instructions for Operation Safety	4
2.1 Protection.....	4
2.2 Basic Safety Rules.....	4
2.3 Security Check for Device.....	5
2.4 Safety Protection for X-ray.....	5
2.5 Notice.....	6
Chapter III System Structure	7
3.1 System Composition.....	7
3.2 System Components and Sub-components.....	7
3.3 Functions of System Components/Sub-components.....	8
3.4 Software System.....	9
Chapter IV Operations and Parts of Electric Module	10
4.1 Electric Control.....	10
4.2 Over Current Protection.....	10
4.3 Emergency Protection.....	11
4.4 Privilege Control.....	11
4.5 Remote Control.....	11
4.6 One-key Shutdown Control.....	11
4.7 Positive & Negative Rotation Control for Motor.....	11
4.8 Thermal Protection for Motor.....	11
4.9 Travel Switch.....	12
4.10 Indicator.....	12
4.11 Connecting Terminal Module.....	12
Chapter V Image Processing and Distinguish	13
5.1 Start the Device.....	13
5.2 Article Check.....	13
5.3 The Image Processing.....	13
5.4 Shutdown.....	24
5.5 Software Operation Manual.....	24
Chapter VI Maintenance and Troubleshooting	29
6.1 Daily Maintenance.....	29
6.2 Safety Notice for Maintaining & Adjusting.....	30
6.3 Changing the Roller and Conveyor Belt.....	31
6.4 Changing and Adjusting the Photoelectric Sensor.....	31
6.5 Changing and Adjusting X-ray Resource.....	31
6.6 Preheating of X-ray Tube in X-ray Source.....	32
6.7 Common Failure and the Maintenance.....	32

Chapter VII After-sales Service	38
7.1 Guarantee.....	38
7.2 After-sales Service.....	38
After-Sales List:.....	38

Chapter I System Overview

1.1 Working Principle

X-ray security inspection equipment is made up of the conveyor, X-ray source and control system, signal collection and processing and transmission system, image processing and electric control. X-ray security inspection equipment completes the check by sending the luggage to the crawler tunnel with the conveyor. Block the photoelectric sensor after the luggage have been sent to the tunnel, and then the detection signal is sent to control module to trigger X-ray source for generating X-ray. After that, a very narrow fan X-ray beam through the collimator penetrates the articles on the conveyor belt and lands on the detector; then, the detector change the X-ray to the electric signal. The weak current signal is quantized directly and sent to the industrial control computer through USB port for further processing. After complicated operation and imaging, a quality image is therefore formed. The operating principle is shown as below:

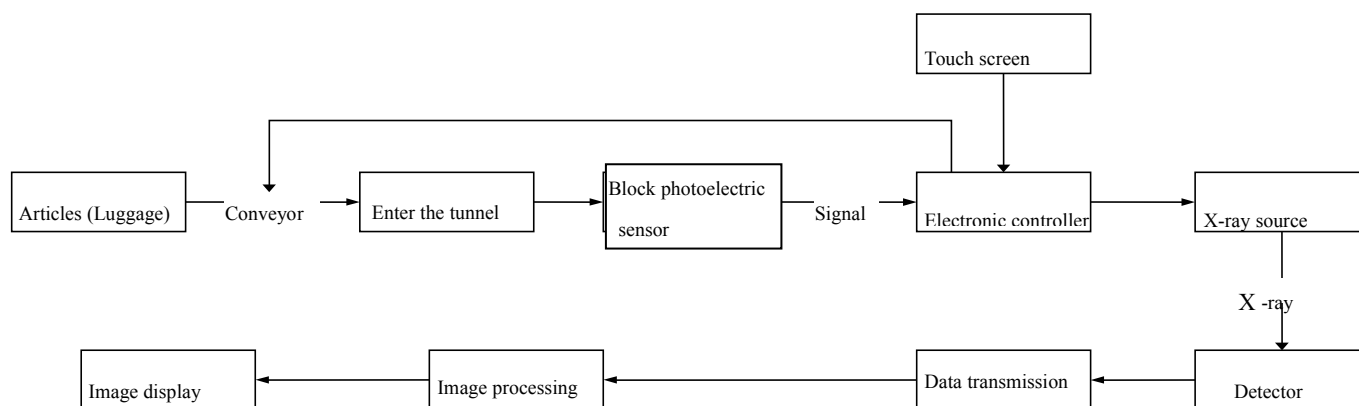

1.2 Special Features and Technical Data

- ★lead curtain: durable and environmental protection, extend service life
- ★Network interface: Capable of connecting to LAN, and support multi-terminal check for baggage at same time
- ★Safety ray: Ray is transmitted under automatic control, avoiding the error
- ★One-key shutdown control: Just rotate the key to shut down the machine; it is safety, easy and convenient
- ★Dynamic image processing functions: some function keys can work in dynamic real-time processing

☆Basic Data:

Tunnel size	500(W) × 300 (H) mm
Conveyor speed:	0.20m/s
Conveyor rated load:	200 kg
Steel penetration:	34mm steel plate
Film safety	For ISO 1600
Leakage radiation:	≤0.1μGy/h

☆X-ray Generator:

Ray orientation: Vertically upward
Tube voltage: 80--160kV (Adjustable)
Angle: 80°
Cooling/working periods: Sealed oil bath with forced air/100%

☆Image Performance System:

X-ray sensor: L type photo-diode array detector; 12bit
Display: High-resolution 19" color LCD display
Color quality: 24-Bit real colors based on materials
Edge enhancement: Object contour edge is more distinct
Super image enhancement: Image detail is more distinct
High penetration display: Increase the contrast of bright area in image to make the area that is easy to penetrate appear more clearly
Low penetration display: Increase the contrast of dark area in image to make the area that is difficult to penetrate appear more clearly.
Magnifier: Partial magnifying function
Brightening/dimming: Increase/Decrease brightness of image
Image recurrence: Display the previous twenty images and process any one of them
Image restoration: Restore image to initial status
Image storage: Real-time store any image and process it in operation status
Color: Organic material is displayed as orange, inorganic material is displayed as blue,

and mixture is displayed as green

☆Operating Environment:

Operating temperature/humidity: 0°C ~ 45°C/20% ~ 95% (Non-condensing)
Storage temperature/humidity: -20°C ~ 60°C/20% ~ 95% (Non-condensing)
Operating voltage: 220V AC (±10%) 50±3Hz
Power consumption: 1.5KW (Max)
Noise level: <58dB

1.3 Elements of Model and Their Meanings

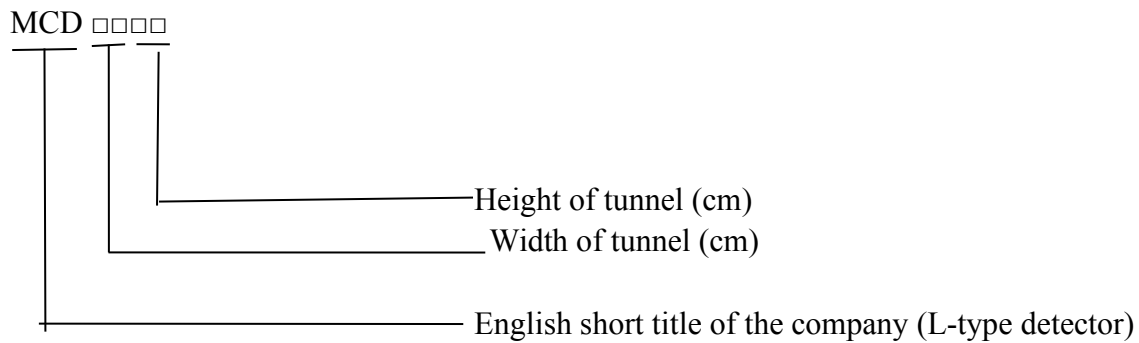

1.4 Main Purpose and Applications

The new powerful MCD-5030C use the latest image technology, which gives higher resolution image for operator to detect all kinds of dangerous articles quickly and effectively. They are widely used in the security check of public areas, such as government agency, embassy, airport, conference center, exhibition center, scenic spot, sports area, post office, shopping mall, hotel, and school. They are fit for the detection of small package, suitcase, and handbag.

Chapter II Instructions for Operation Safety

2.1 Protection

MCD-5030C is X-ray equipment with radiation. We have tried our utmost efforts to ensure the safety of system in design that it can protect the security of operators and maintainer in any condition. However, the following safety rules should be followed during their use, installation, and maintenance.

Rules and conditions

1. GB 15208-2005 Micro-dose X-ray security inspection system
2. GB 4208-93 Degrees of protection provided by enclosure (IP code)
3. GB 18871-2002 Basic Standards for protection against ionizing radiation and for the safety of radiation sources
4. Law of the peoples Republic of china on prevention and control of radioactive pollution

2.2 Basic Safety Rules

Though MCD-5030C X-ray security inspection equipment is easy to operate, we still recommend you to read this user manual completely before starting the device, and follow the rules below:

1. If you have not used the device for over 6 months, please do not start it before the professional technologist restarts the X-ray generator; otherwise, the X-ray generator may be damaged.
2. You should know the relevant radiation protection rules before operating MCD-5030C X-ray security inspection equipment.
3. If other person wants to operate the device, make sure he/she is a qualified operator, and knows all safety indications, laws, and regulations.
4. The installation, electrical connections and the change of MCD-5030C and electrical parts should be done by experienced professional technologist only.
5. If the shell, cable, or conveyor belt of the device is damaged, please stop the operation immediately.
6. The shell plate and parts of MCD-5030C X-ray security inspection equipment should only be opened by qualified technologist.
7. Do not modify or change any parts that are related to the system safety. The installation, test, or maintenance of the device should only be done by persons who have passed the training.
8. The device is for checking the articles only. Do not use it for person or other living things.

-
9. Do not sit or stand on the conveyor belt.
 10. Any part of the body is not allowed to be in tunnel when starting up the devices.
 11. Make sure the luggage is not piled up in the tunnel or outlet! If the luggage blocks the tunnel, please turn off the device before clearing.
 12. Prevent the liquid spilling on the device. Turn off the device if such situation happens.
 13. Do not block the thermovent of MCD-5030C X-ray security inspection equipment and the display.
 14. The device should be connected to the ground before working. The main socket and the installation field should be equipped with reliable grounding equipment.
 15. Try to avoid standing by the outlet and inlet of the device when it is working.
 16. Stop the operation if the lead curtain is damaged or opened.
 17. Though there are very few X-ray, non-operator should also try to be away from the device.

2.3 Security Check for Device

1. Check the lead curtain that used for preventing the leakage of X-ray in inlet and outlet of tunnel before starting the device. Change the curtain if it is damaged.
2. Check whether there are objects blocking the photoelectric sensor.
3. Check whether the conveyor belt is sound, whether there is spine or dirt that harms the luggage, and whether the conveyor is deviated or blocked.
4. Check whether there is damage on the shell panel, display, keyboard, and cable of the device.
5. Make sure all cover plates are covered.

2.4 Safety Protection for X-ray

MCD-5030C X-ray security inspection equipment takes some reliable protection measures for X-ray radiation, which effectively ensure the safety of operator and other persons.

These measures include:

1. The X-ray source of the system is the active component, which only gives out X-ray under high voltage. Therefore, there will be no X-ray when the device is not connected to the power supply, such as when it is in transportation and storage.
2. The X-ray amount of single detection is only 0.3 μ Gy/h, the machine cabinet and collimator are shielded by lead plate, and the inlet/outlet is equipped with lead curtain; all these measures prevent the harm

of X-ray effectively.

3. To ensure the safety of maintainer, two interlocked switches are used (The device does not .emit X-ray once any of the interlocked switches is cut). The device does not emit X-ray when the conveyor is stopped or when there is no articles in the tunnel, avoiding harming the maintainer.

4. Setting grounding in several places can effectively avoid the electric shock and the damage to device.

5. The device has multiple protections, such as overload and over current protection, which minimize the possibility of accident and risk.

6. Our X-ray security inspection equipment fully meets the safety requirements in X-ray national standards GB15208-2005.1.

The design of MCD-5030C X-ray security inspection equipment can protect the safety of operators and maintainers in any time. The system has very low X-ray dose while ensuring enough penetration for checking the articles. It does not influence the sensitive materials, foods, medicine, and tapes for even several irradiation.

The device is equipped with large lead screen for preventing the leakage of X-ray. The lead curtain almost minimizes the radiation to zero. Besides, interlock switches are installed in X-ray emission place and the detector box. The control circuit is monitoring the interlock switches in case when any interlock switch is disconnected, the device will cut the AC power supply of X-ray controller, and therefore cut off the X-ray.

The X-ray source of the device does not emit X-ray after the power down.

2.5 Notice



1. Any device that emits X-ray will do harm to people. Please try to shorten the time of exposing in the radiation environment, and pay attention to the protection.

2. The external power grid and power supply should have good grounding that has connected to the ground.

Chapter III System Structure

3.1 System Composition

The system includes hardware and software.

1. Hardware

- (1) X-ray generator controller
- (2) X-ray detector
- (3) Data collector
- (4) Machine frame

2. Software

- (1) Software for system control
- (2) Software for image processing

The system composition structure is as below.

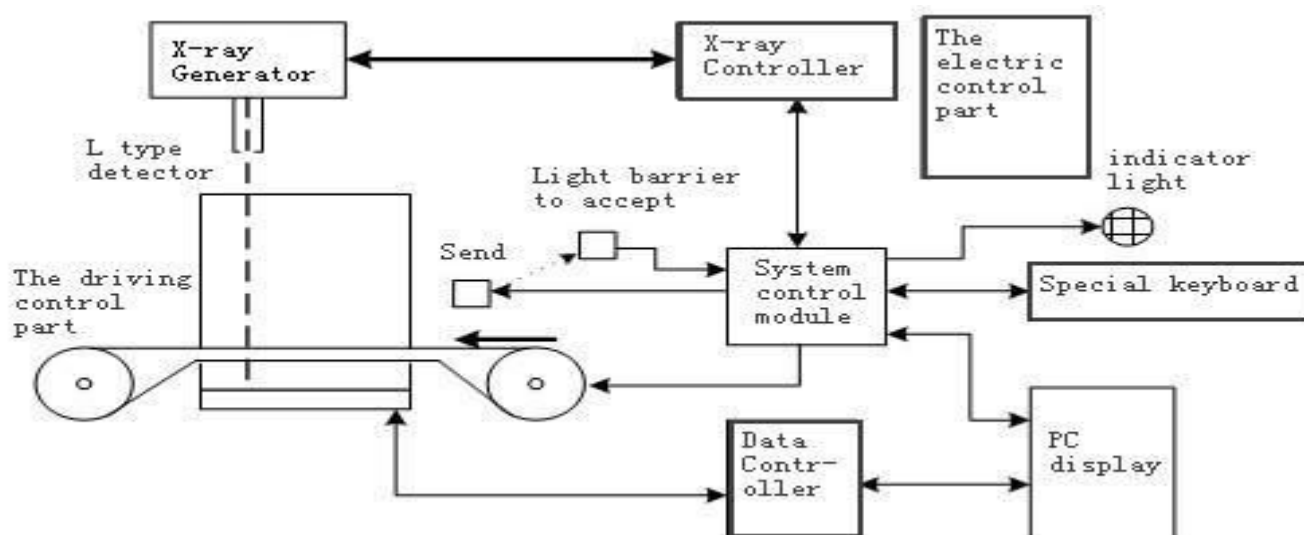

3.2 System Components and Sub-components

The system components and sub-components include:

- (1) X-ray source
- (2) X-ray source control and driver
- (3) X-ray detector array kit
- (4) Electronic controller
- (5) Industrial control machine
- (6) Display
- (7) Auxiliary relay
- (8) Key switch

-
- (9) Conveyor
 - (10) Photoelectric sensor
 - (11) Power panel

3.3 Functions of System Components/Sub-components

1. X-ray source

X-ray source includes three parts:

- (1) High-voltage generator (Two voltage doubles and reactive circuits)
- (2) X-ray tube
- (3) Collimator

X-ray tube and the high-voltage generator made up by two voltage doubles and reactive circuits are put in the shell with lead screen that is filled with oil. Cable WS9 offers filament and high-voltage driving signal for the X-ray source, and feeds back the sampling signal of high-voltage and anodic current to X-ray control and driving case to maintain the stability of high-voltage and anodic current during the detection. The collimator is used for changing the X-ray beam to fan beam.

2. X-ray detector array kit

Two detector arrays form an L shape to smooth away the detecting dead angle. Vertical side (Named as "Side detecting box" below) has detector panels, and horizontal side (Named as "Bottom detecting box" below) has detector panels, in which there are 32 tunnels for each panel. The high-energy analog signal is magnified and digitized on the detecting panel, and sent to the industrial control computer for processing.

3. Electronic control box

The control panel is in charge of receiving and forwarding the PC command from industrial control computer to control the motor to run or stop. It also monitors the status of photoelectric sensor, judges the entry/ exit of luggage, controls the X-ray emission, and monitors whether the X-ray control module is work normally. If there is any unusual action, it will give an alarm automatically.

4. Image processing system

The device has one digital image processing set, also called as industrial control computer. The industrial control computer receives the detector signal from X-ray source, and processes the sample detector data.

(1) Image processing

The device offers the basic image processing functions, such as edge enhancement, super image enhancement, pseudo color, and enlargement.

(2) Data storage and search

The device offers functions of storing and searching the image, as well as recording the operating situations of the operators.

5. Display

The system is equipped with 19" high-resolution display, which can display color image or B/W image as required. The PC computes the actual value of input information, and makes the direct response, realizing the device control and image processing.

6. Conveyor

The conveyor includes:

- (1) Conveyor Belt;
- (2) Electrical roller in outlet end of conveyor;
- (3) Driven roll in inlet end of conveyor;
- (4) Dragging roller in the running direction of two driving belts under the device

The electrical roller has one single-phase motor. The driving torque of motor is transmitted to roller surface by the gear reducer to form the force of driving the belt. The driven roll is used for adjusting the tension of belt.

7. Photoelectric sensor

There equips a pair of photoelectric sensors (Opposite-type photoelectric switch) in the inlet of tunnel for detecting the luggage carried into the tunnel by the running conveyor belt. If the luggage blocks the photoelectric sensor, the receiving end of photoelectric sensor will send a signal to the electronic controller, which will therefore inform the X-ray controller to emit the X-ray.

3.4 Software System

Image processing is to process the received signal, and display it on the screen for operators' distinguish. EEH & NEG, pseudo color (C/B), and partial penetration enhancement (HIGH/LOW) functions are offered for the convenience of identifying the prohibited articles. Image processing functions, such as image recurrence and enlargement, it is convenient to identify prohibited items.

1. Operating environment

Windows XP

2. Software compositions

(1) Special driver

(2) User control interface

User control interface

- Control the system hardware and achieve the automatic data acquisition
- Read the data acquisition system in regular time
- Offer interface for image processing
- Analyze and process the output of image
- Offer user-friendly interface

Chapter IV Operations and Parts of Electric Module

4.1 Electric Control

Electric system is an important part of security check system; it offers power supply for the entire security check system as well as providing relevant electric protection when there is accident. The operators operate the device on the control table. The electric schematic diagram is shown in Figure 4.1:

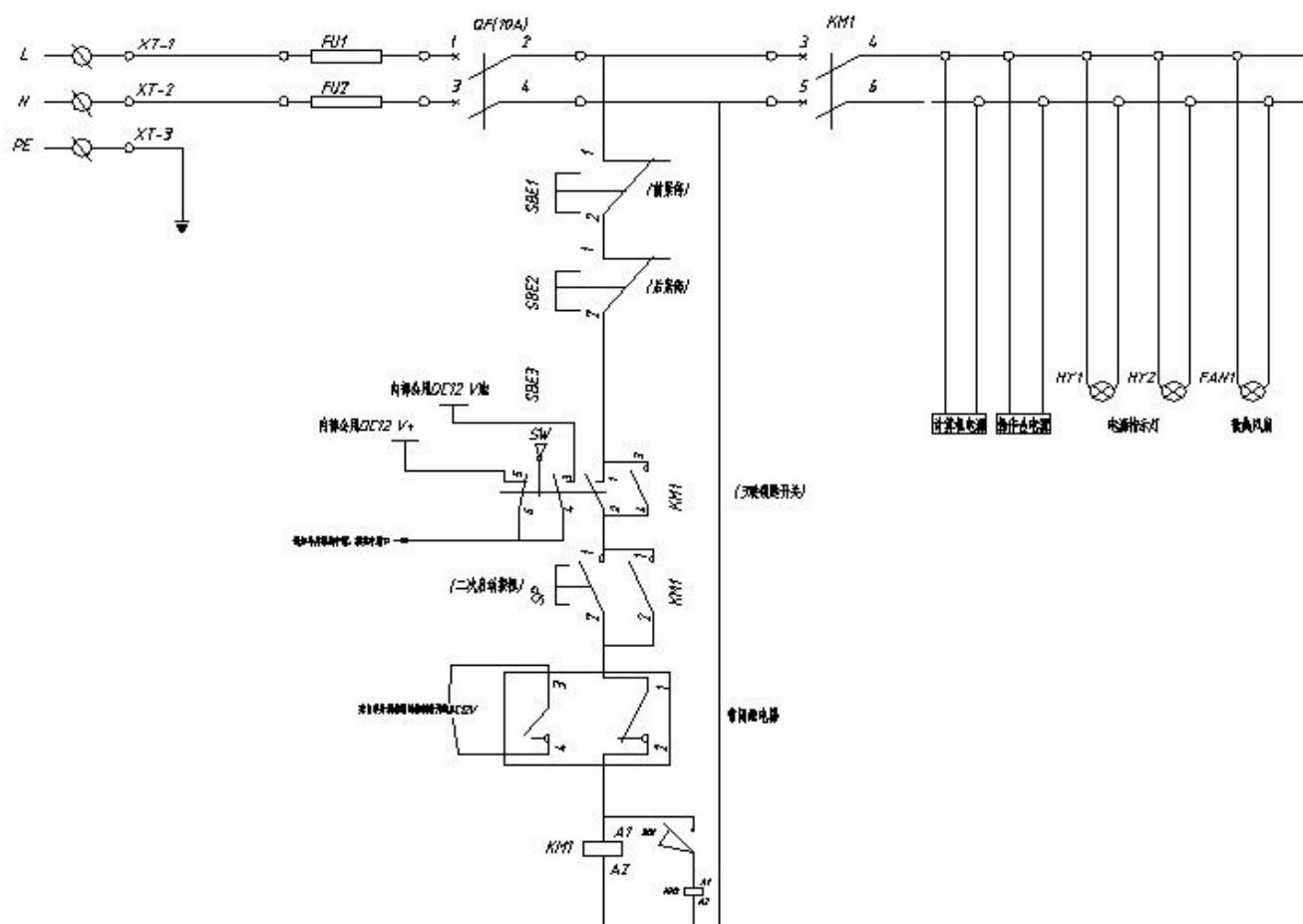

Figure 4.1 Original figure of electric control

The electric part mainly realizes the following functions:

4.2 Over Current Protection

In Figure 4.1, FU1 and FU2 are 10A solid fuses and the actual power of the device is 1500W, this design allows the circuit to have the max power 2200W, which meets the actual requirement of the device. A circuit breaker is installed behind the fuse that when there is a short circuit in the back-end, it will release the circuit instantly to protect the device.

The short circuit is caused mainly by the aging insulating layer, loosened terminals, and the personal factor.

4.3 Emergency Protection

In Figure 4.1, SBE1 and SBE2 are emergency stop buttons. The buttons are installed near the operator on the shell of device for cutting the power supply in case of the emergency. They are connected in the major loop of the control part. The selected model is of $\Phi 22$ and 10A, which meet the requirement of the device.

4.4 Privilege Control

The device is operated by trained full-time staff only. Therefore, there require to have privilege control. Two schemes are used; one is for electric control, and the other is for software control. The electric control is achieved by controlling the SW key switch shown in Figure 4.1, which is connected in series in major control loop. You can choose 2 to open, or 1 to close the loop. Only people with the key switch can operate the device, thus preventing the mistake triggering by others.

4.5 Remote Control

With remote start-up control, the control buttons can be installed on the control table separated away from the main device. The control table can be put in a room or a needed place while achieving remote control using the extended power line.

4.6 One-key Shutdown Control

In actual application, there will be error operations on the key switch. For example, the operators rotate the key switch in the reverse direction by mistake, causing the power failure of the major loop; or they touch the key unconsciously that causes the power failure of key switch. Such operations may have a great impact on the sudden power failure of the load, such as computer. The products designed by our company can achieve the safety shutdown by just revolving a key switch.

4.7 Positive & Negative Rotation Control for Motor

The motor is required to have positive & negative rotation during the normal operations. For example, if there is an article blocking the photoelectric sensor during the self-checking, the belt needs to be rotated positively or negatively based on the situation; or when the image is not clear enough and you want to have a clear image, you can return and use the positive and negative rotation. The circuit is done by using an intermediate reversing relay.

4.8 Thermal Protection for Motor

In actual application, the motor may have over current because of long time operations or overload. Therefore, it is necessary to protect the motor. The system will protect the motor when the current comes to a certain level.

4.9 Travel Switch

Travel switch is mainly used for protecting the safety of human. The X-ray is harmful to human that when people touch the X-ray emission device, the X-ray emission should be stopped immediately for the safety. The travel switch is therefore installed beside the X-ray generator control device, and connected in series with X-ray generator to protect the device from short circuit.

4.10 Indicator

All indicators should be installed on the surface of the device for giving indications. They include X-ray indicator, alarm indicator, and power supply indicator.

1) Power supply indicator: Turn on the key switch to start the device. The yellow power supply indicator on the panel in front of the tunnel will be on immediately.

2) X-ray indicator: X-ray indicator is installed on the panel in inlet and outlet of the tunnel. X-ray is emitted when the articles enter the tunnel and blocks the photoelectric sensor, and then the red indicator is on.

3) Alarm indicator: There is one alarm indicator in inlet and outlet respectively. They flash and alarm when there is suspicious article.

4.11 Connecting Terminal Module

In a system connection terminals are using screw type PCB terminal blocks, by cold-press terminal, line groove to go around the line. As shown in figure 4.2.

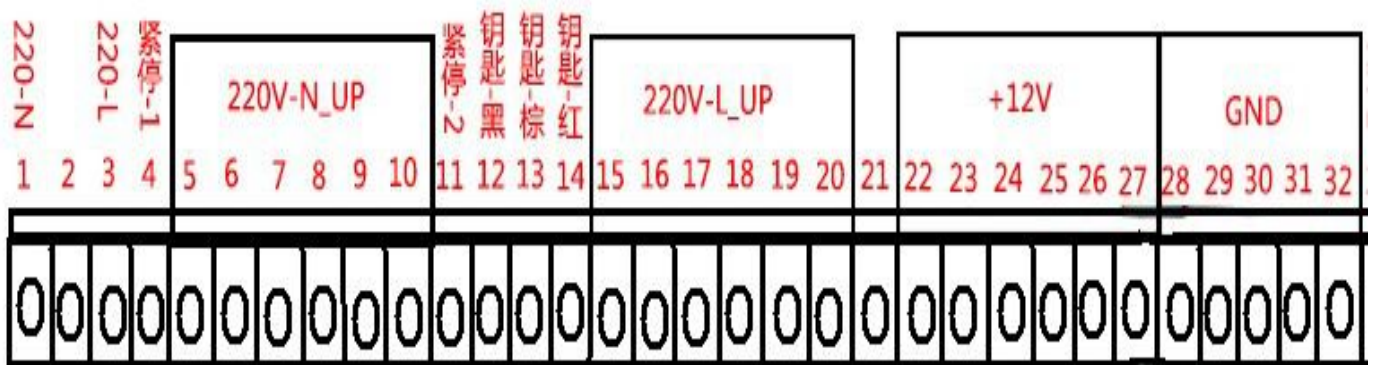

Figure 4.2 connecting terminal module

Chapter V Image Processing and Distinguish

This chapter introduces the software operations of the device in details.

5.1 Start the Device

- Insert the key in the key switch and rotate it clockwise; then, press the green button to start the device;
- Power supply indicator on the device is on, and then the waiting indicator is on.
- The system enters into the software application interface.
- The program checks the tunnel automatically to see whether there are foreign objects. The conveyor belt will run if there are foreign objects. The software system initiation is over when the foreign objects are cleaned.

5.2 Article Check

- Put the articles to be detected on the conveyor belt.
- Press “Forward” button to control the operation of motor, and start the conveyor belt.
- The articles will block the photoelectric sensor once they enter the tunnel to start the X-ray generator.
- The device carries out the non-interlaced scanning for the articles when they are going through the tunnel. The relevant detected image is shown on the display immediately while, refreshing without stop, transferring from right to left.

5.3 The Image Processing

In order to better identify prohibited items in package. The system software has H/LE,C/G,ZOOM,FW and BW etc a variety of image processing functions, users can use Keyboard as shown in Figure 5.3 to achieve "a key image processing", convenient operation, when users use wrong processing functions. Also press the "RES" button can be restored to the original image, Below is detail instruction for common use image processing functions.



Figure: 5.3 Customized keyboard

5.3.1 Color and Black/White Color

Color and B/W image are available. The default image obtained from scanning the articles is 256-level gray images, whose gray scale is from black to full white. The gray scale is in direct proportion to light strength of X-ray source and the actual X-ray absorption of scanned articles. Articles with different absorption have different gray scales. You can click "C/G" button to switch between color image and gray image.



Figure: 5.3.1 Color effect

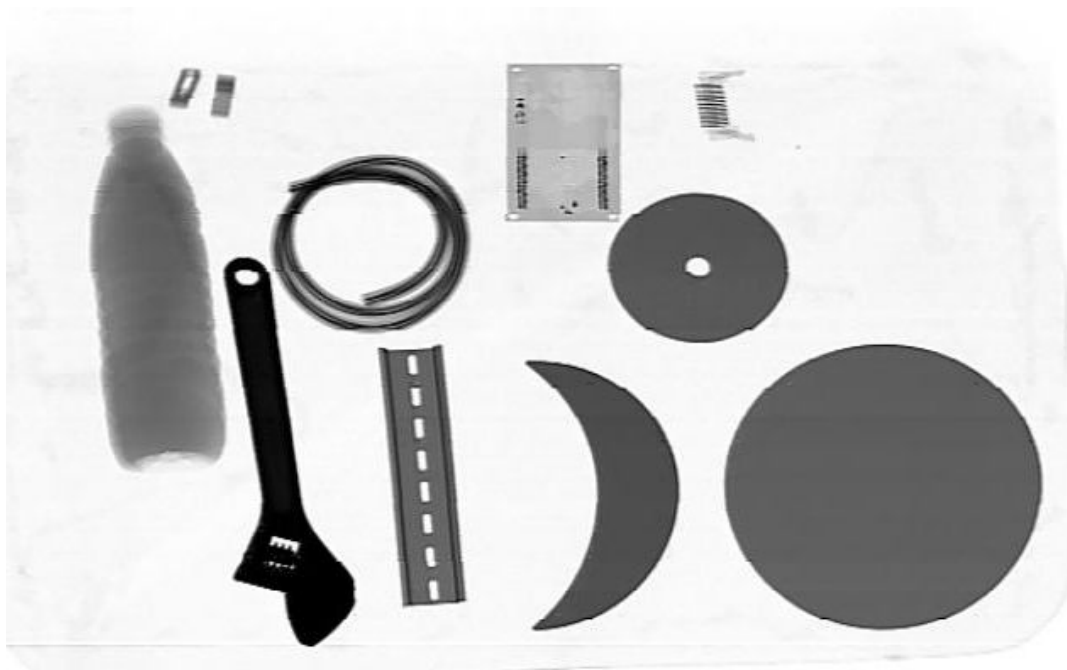

Figure:5.3.1 Gray effect

5.3.2 Reverse Color

In the detected image, article that has high absorption rate for X-ray is generally shown as dark black while for article that has low absorption rate, it is shown as brilliant white. In reverse display, this condition is just reverse. You can click “REV” button to swap the display of positive/negative film. In this way, small or thin articles (such as metal wire) with high density will be shown more clearly.



Figure 5.3.2 Original effect

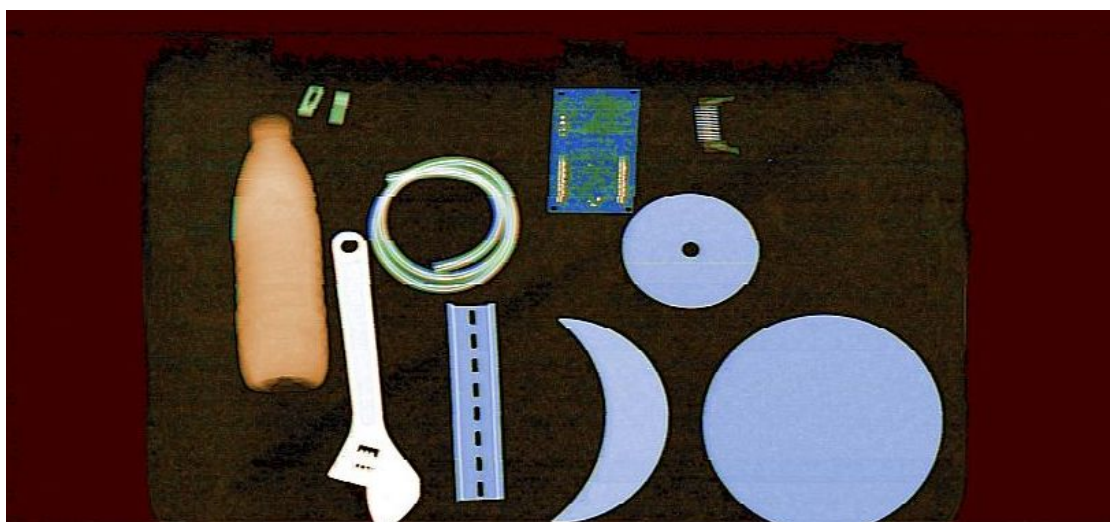

Figure 5.3.2 Reverse color effect

5.3.3 Edge Enhancement

When detecting some metal articles that are thick, such as can and winding, the X-ray image may be a little bit dim because they are hard to be penetrated by the X-ray. In this way, you can click "BEH" to enhance the penetration for the image to get the optimal contrast and lightness.

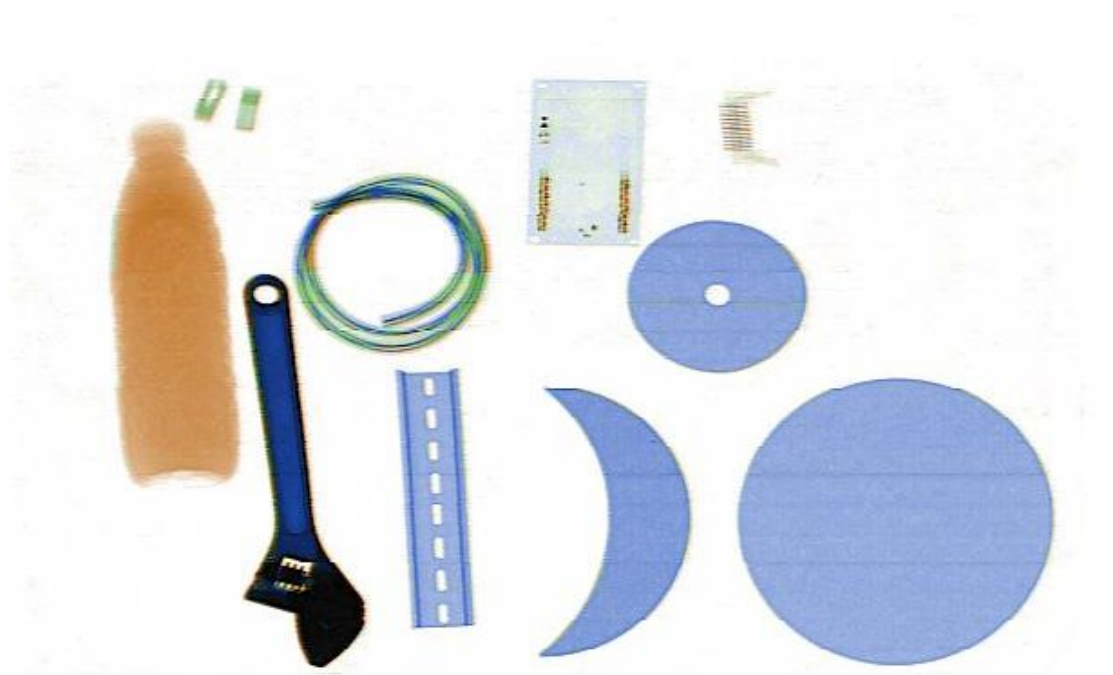

Figure 5.3.3 Original image

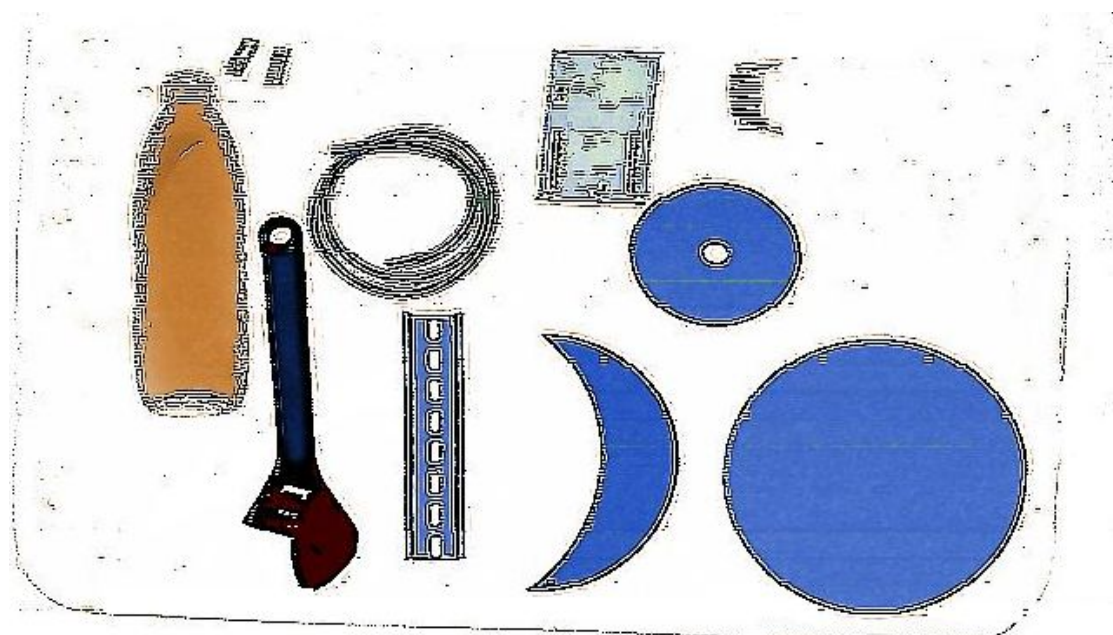

Figure 5.3.3 edge enhancement effect

5.3.4 Penetration Enhancement

Click "PEH" button to partial enhance the current image.



Figure 5.3.4 original image



Figure 5.3.4 partial enhance effect

5.3.5 High Penetration

Click "HP" button to make current image more brighter, lower contrast. It will display as Figure 5.3.5



Figure 5.3.5 original image

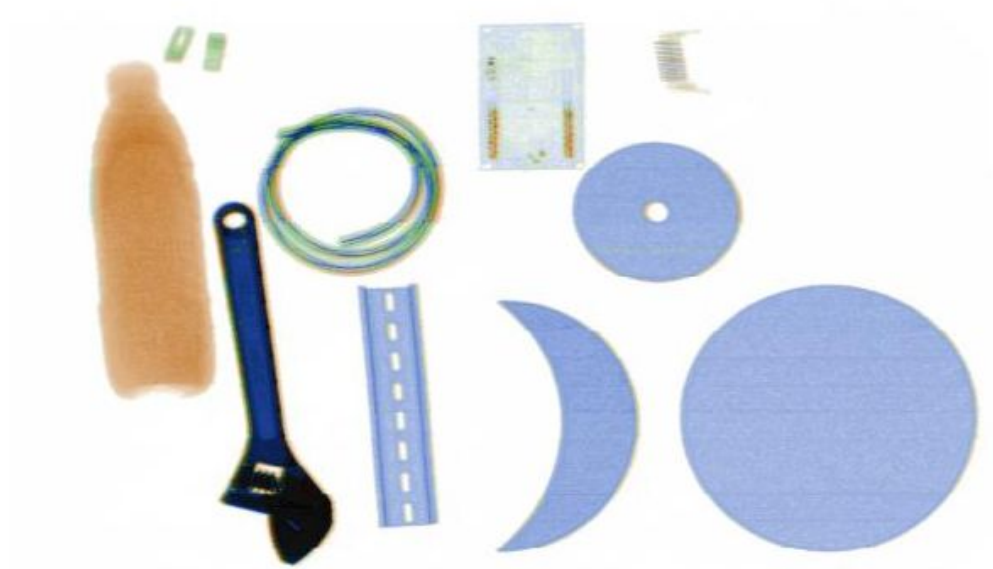

Figure 5.3.5 high penetration effect

5.3.6 Low Penetration

Click "LP" button to make current thick and dark image more brighter, lower contrast. It will display as Figure 5.3.6



Figure 5.3.6 original image



Figure 5.3.6 low penetration effect

5.3.7 ORG



Figure 5.3.7 original image

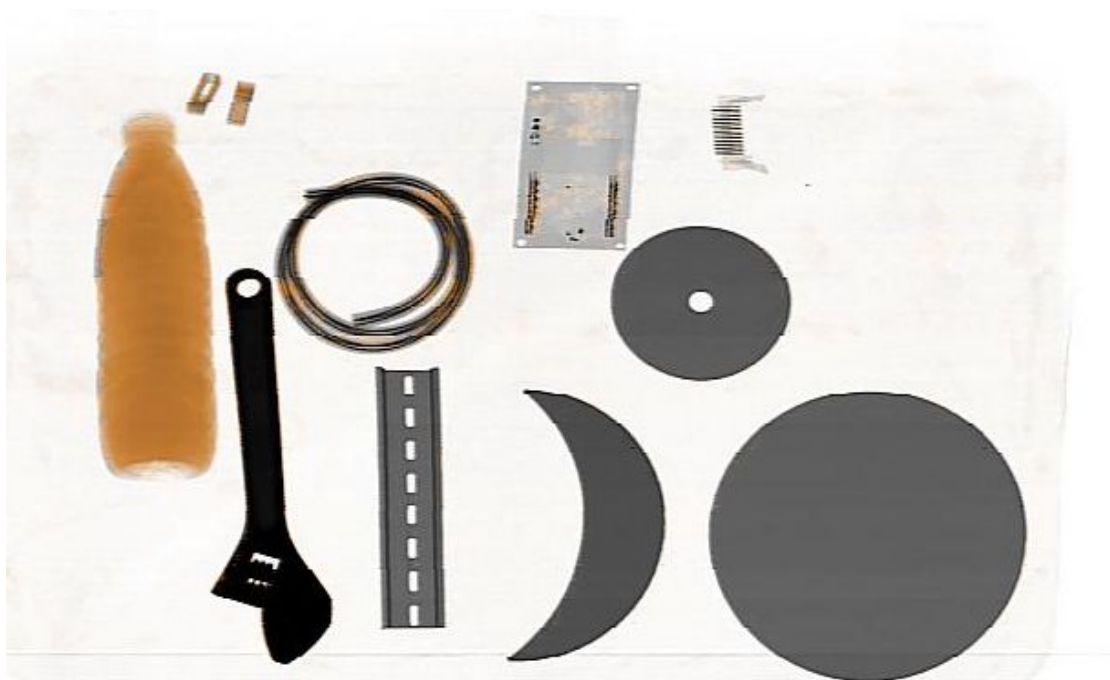

Figure 5.3.7 organic effect

5.3.8 MET



Figure 5.3.8 original image



Figure 5.3.8 inorganic effect

5.3.9 Image Enlargement

Click "Zoom" button to enlarge the current image. It is also able to realize the movement observation.



Figure 5.3.9 Original effect



Figure 5.3.9 Zoom effect

5.3.10 ATGR

Click "ATGR" button, Image will display as Figure 5.3.10



Figure 5.3.10 original image

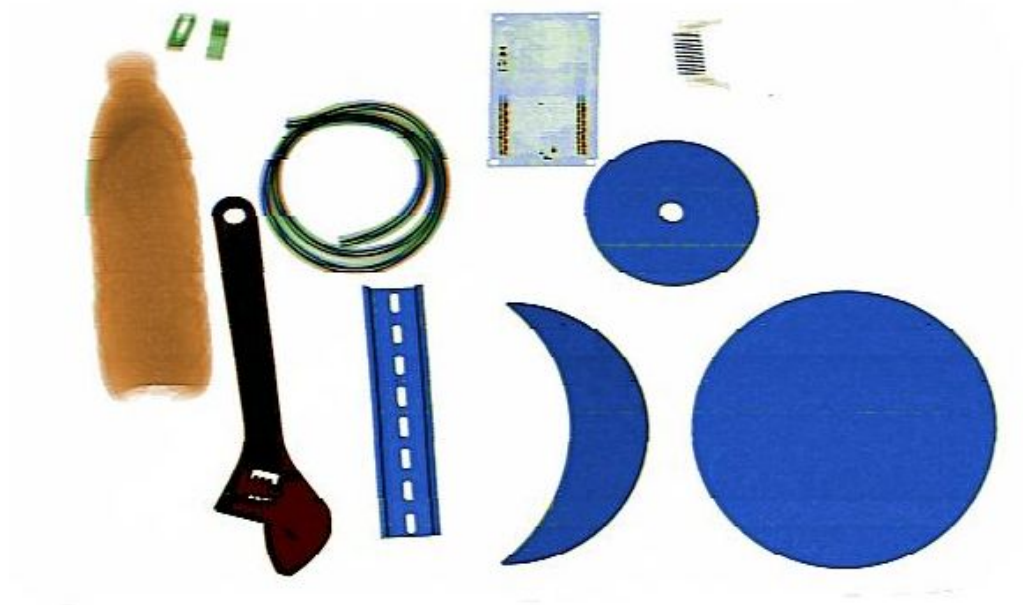

Figure 5.3.10 gray scanning effect

5.4 Shutdown

(A) Make sure there is no articles left on the conveyor belt. If it is necessary, run the belt forward or backward until there is no article on the belt.

(B) You can just left rotate the key switch to shut down the computer safely without any other operations. It is very simple, convenient, and personalized.

(C) Pull out the key, duty off or handover the work

5.5 Software Operation Manual

System software includes image display and menu operation, can see metal structure in package by display screen , understand the equipment working state, Menu operation provides image display Settings, image retrieval, intelligent control, etc.

5.5.1 Image Display Interface

As shown in figure 5.5.1.1, image display interface mainly showed roller,data transport and X ray and Roller control state.whether they are open, close etc.At the same time,Also supply User login button.



Figure 5.5.1.1 image display interface

When Roller Close and X Ray Close,It will display as Figure 5.5.1.2

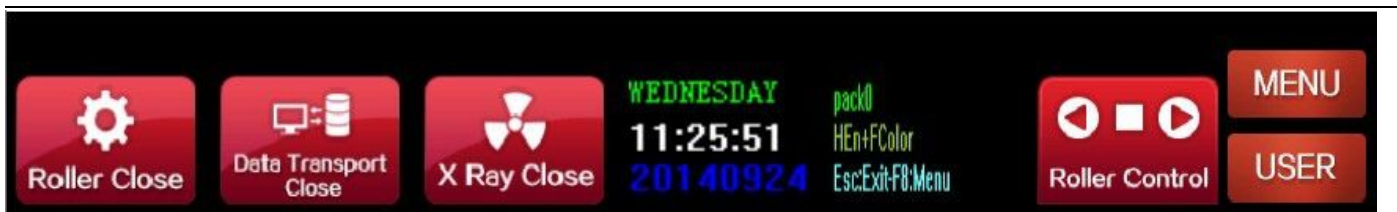

Figure 5.5.1.2 state display interface

When Roller Open and X Ray Open, It will display as Figure 5.5.1.3



Figure 5.5.1.3 state display interface

5.5.2 User Login

When users press the "F7" keys on the keyboard in image display interface. It comes out Figure 5.5.3, You can log in the system after the user name and the password had been set. As shown in the above picture, the login number is for the user name.



5.5.3 login interface

5.5.3 Menu Functions

When users need to modify the Settings in the operating menu, you must first login with a valid account software, modify the Settings to take effect, the user to change the Settings, simply click on the "apply" button in the corresponding function box (or "set" button), exit the software can be reopened software after, in the operating menu mainly contains the image Settings, files, Settings, such as ground point set 7 sub menu.

5.5.4 Image Settings

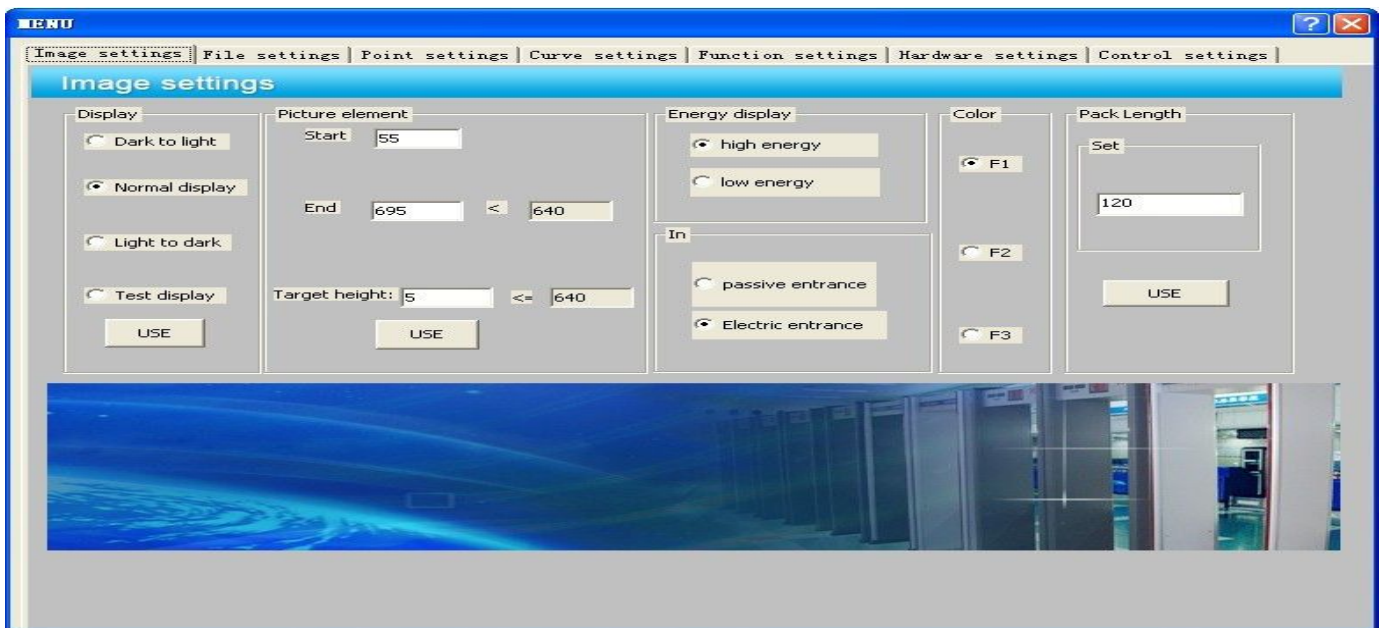

5.5.4 image Settings menu interface

5.5.5 File Settings

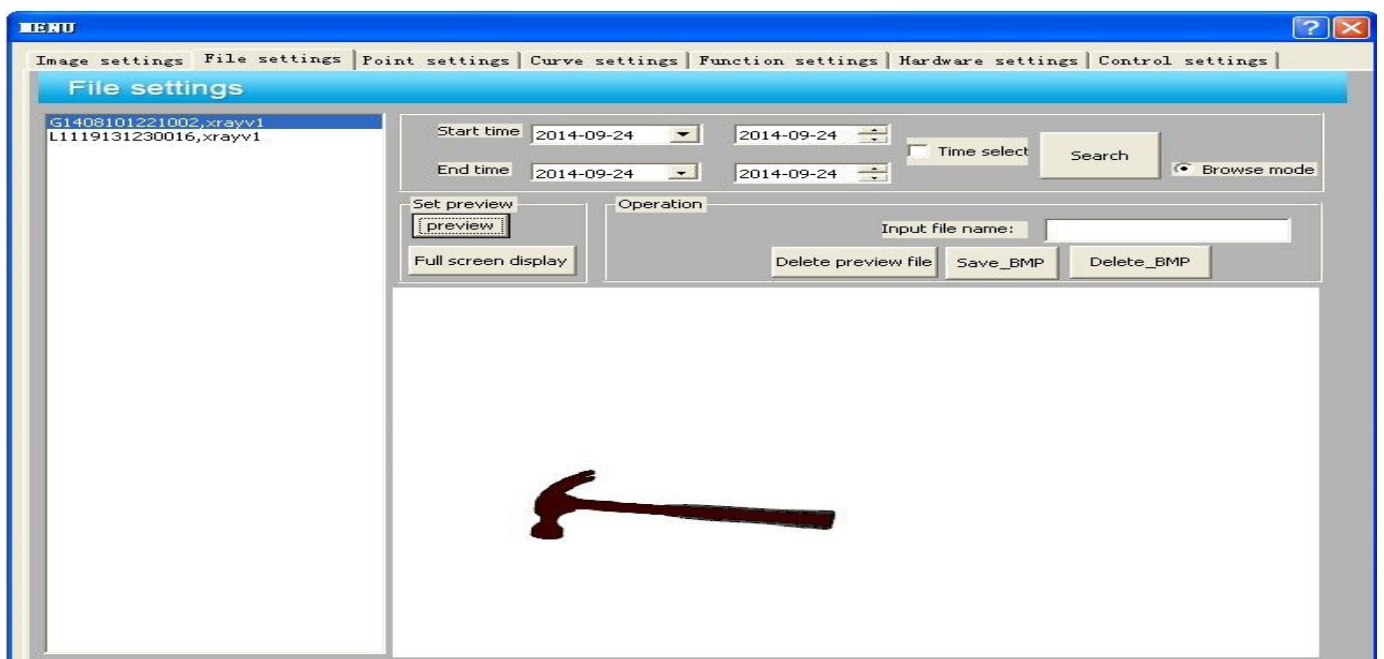

Figure 5.5.5 file Settings menu interface

5.5.6 Point Settings

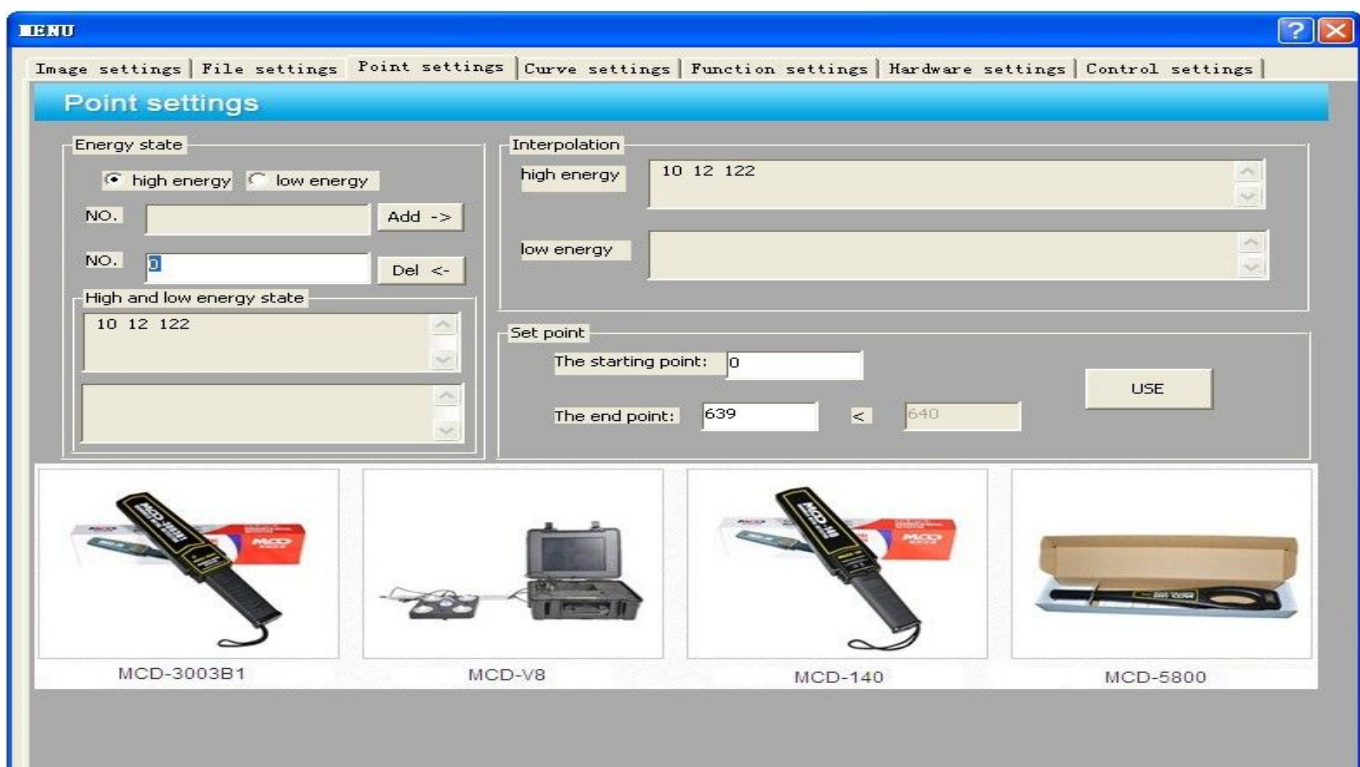

Figure 5.5.6 point settings menu interface

5.5.7 Curve Settings

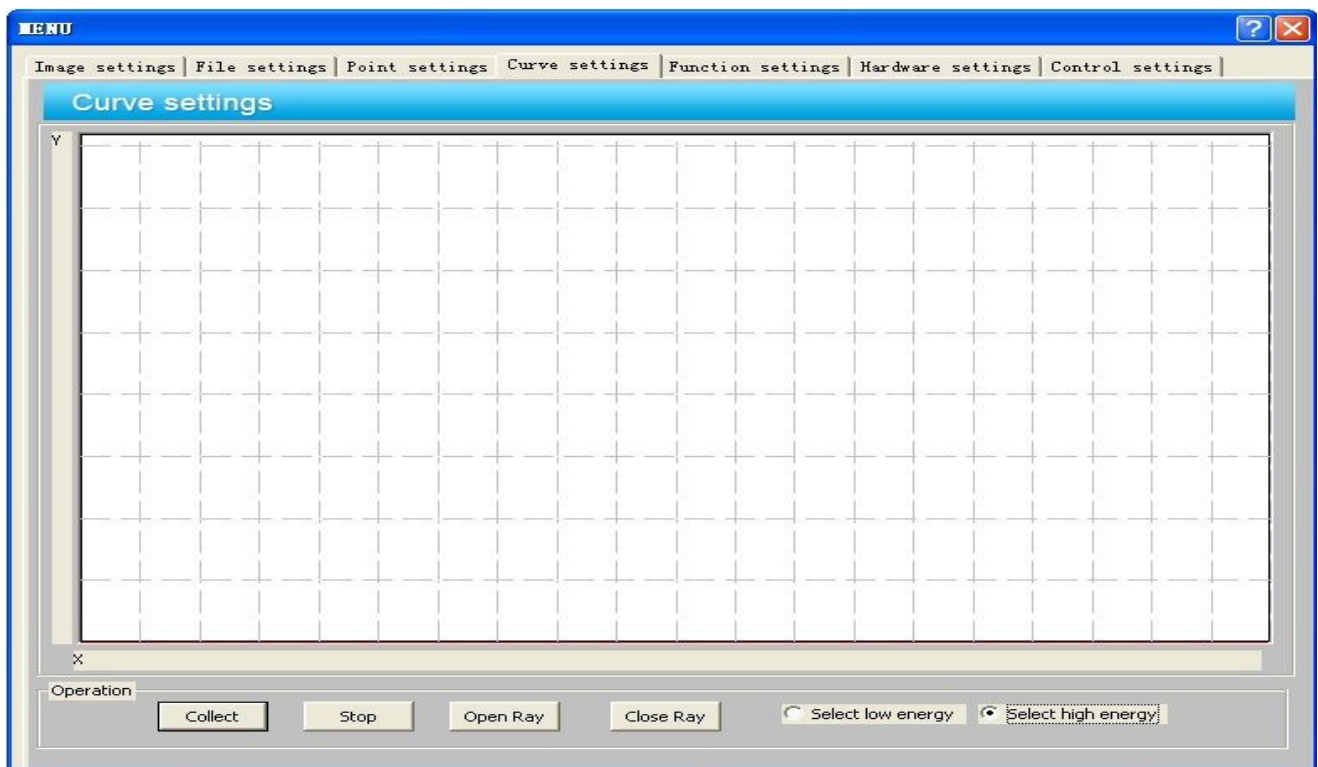

Figure 5.5.7 curve settings menu interface

5.5.8 Function Settings

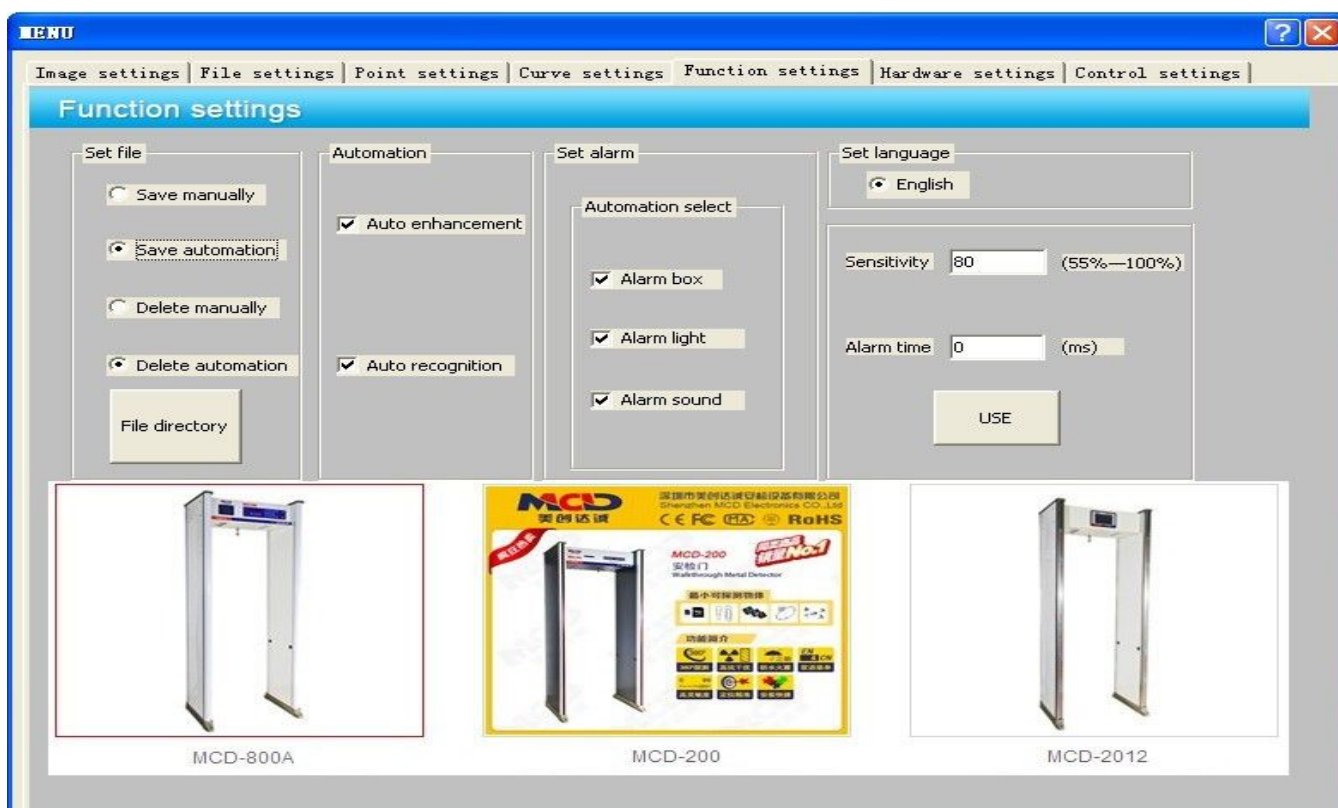

Figure 5.5.8 function settings menu interface

5.5.9 Hardware Settings:

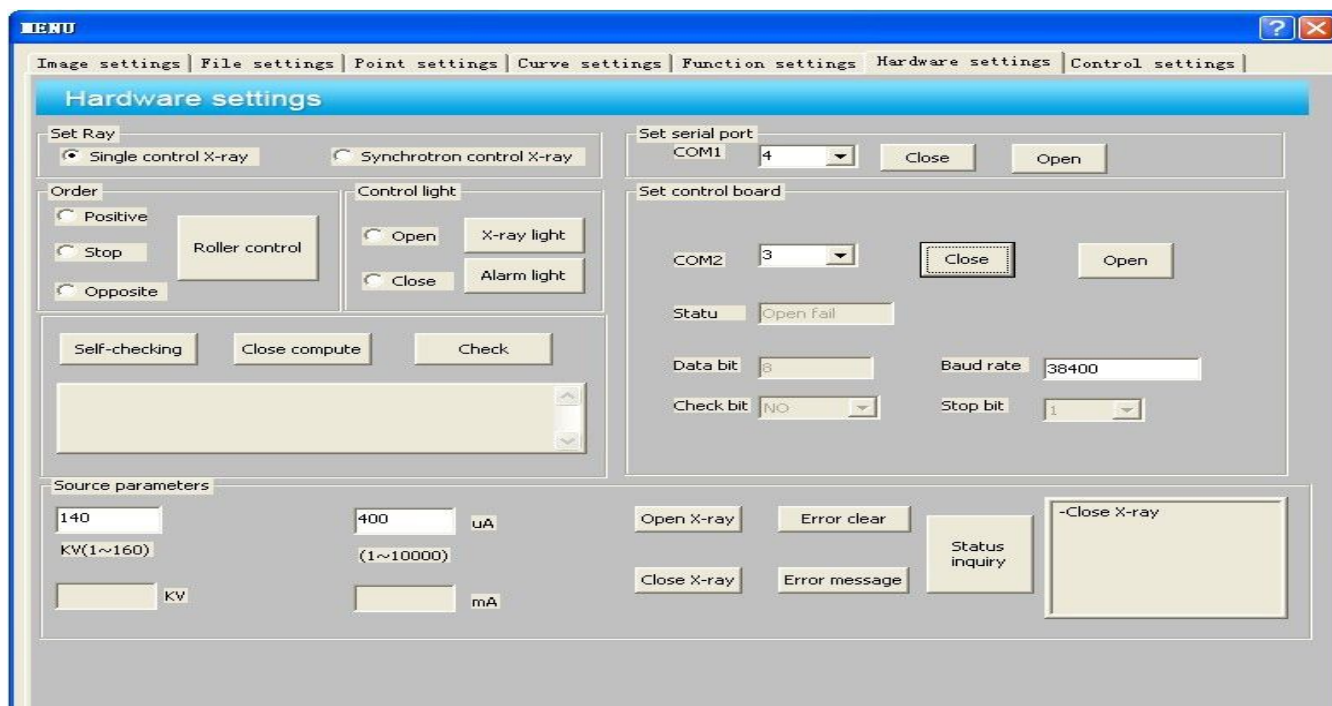

Figure 5.5.9 hardware settings menu interface

Chapter VI Maintenance and Troubleshooting

X-ray security check system is the high-tech combination of machinery and electronics. Therefore, the users should not only get to know the technical performance, structure, principle, and the operating instructions of device, but also they should be good at the daily maintenance, which can fully show the performance of device, extend the useful life, and ensure the safety of device and human.

6.1 Daily Maintenance

To make sure the actual operations to be consistent with the technical data in the user manual, the device should be checked and adjusted in the regular intervals.

The maintenance should be done by the trained person authorized by the company.

The maintenance of device hardware should be done after the power supply has been cut.

1. Normal maintenance

- (1) The device should be installed in a dry place with good ventilation and less dust. Try to be away from high temperature, damp, or direct sunlight.
- (2) Clean the dust with hairbrush and cleaner first when maintaining the device.
- (3) If the components or connector lugs are loosened, fasten them immediately.
- (4) When there is corrosion in some components, change the components if necessary.
- (5) If there is a damaged component, find the reason, clear the failure, and change for a new component. The relevant parameters should be set before the component could be use normally.
- (6) To prevent the electric leakage or accident, do not get any foreign objects or liquid inside the device during the maintenance.

2. Details of maintenance

- (1) Check the power supply indicator on the upper part of the device.

The yellow indicator is on when the device is electrified.

- (2) Check the X-ray indicator on the upper part of the device.

The red indicator is on when the X-ray is emitting.

- (3) Check the emergency stop button above the tunnel.

The device stops immediately when you press the emergency stop button. The device cannot be started again when the button has not reset.

- (4) Check the key switch above the tunnel

The starting button can start the device only after the key switch is turned on. The X-ray stop button can cut the power supply of X-ray controller. If the key switch is not sensitive enough, please change it for a new one.

(5) Check whether the touch screen is consistent with the screen image

For example, the image is zoomed out when you press the “Zoom out” key; the image changes correspondingly when you press the image processing keys.

(6) Check the photoelectric sensor of the inlet

Put an opaque object on the running conveyor belt, and the X-ray source can be turned on. After the power supply is cut, use the dry silk cloth to clean the lens of photoelectric sensor and the windows on the wall of tunnel.

(7) Check the driving roller

The driving roller will run in the scheduled direction or stop when you press the corresponding keys. The noise should be normal, and there should be no fuel leak.

(8) Check the travel switch on the detecting box and collimator

The X-ray emission stops when any one of the cover plates is disassembled.

(9) Check the conveyor belt

Check whether the conveyor belt is deviated from the motor.

(10) Check the thermovent

Check whether the thermovent is blocked; clear the dust on it.

6.2 Safety Notice for Maintaining & Adjusting

1. To prevent the damage of device or the safety accident, do not get any foreign objects or water inside the device during the maintenance.
2. There are many parts, whose operating voltage is 220V, in the device. The normal maintenance should be done when the power supply is cut. If the operation requires to be connected with the power supply, it should be done by trained person while having the anti-electric-shock measures.
3. There are many precise electronic devices. Make the preparatory treatment to prevent static damaging the device before maintaining.
4. There are several places of lead sheath, which is used for preventing the X-ray leakage. You'd better wear the cotton glove during the operation. If you cannot wear the glove, make sure to wash your hand after the work.

-
5. Recheck the device carefully before connecting to the power supply to make sure the connection is correct.
 6. Before starting the X-ray source, please cover the cover plate to avoid the X-ray damaging the human.

6.3 Changing the Roller and Conveyor Belt

1. Cut the power supply first, and then disconnect the cable of the motor.
2. Disassemble the cover plate, and screw down the fixing bolt on conveyor and frame to demount the conveyor.
3. Loosen the tension bolt and release the belt, so that you can disassemble and change the driving roller or adjusting roller.
4. Change the conveyor belt
 - (1) Nip off the damaged adhesive tape and take it out.
 - (2) Carry out the pre-processing treatment for the new adhesive tape in the factory before the cold glue joint based on the perimeter of original adhesive tape.
 - (3) Carry out the cold glue joint technique for the new adhesive tape on site.

6.4 Changing and Adjusting the Photoelectric Sensor

Adjust the photoelectric sensor as the following steps:

1. Cut the power supply of the device, and open the cover.
2. Disconnect the cable of the photoelectric sensor.
3. Screw down the two fixing bolts on the photoelectric sensor.
4. Change for a new photoelectric sensor, and fix it after adjusting the photoelectric sensor to a proper position.
5. Solder the cable outlet of photoelectric sensor to the connector based on the drawing.
6. Connect the cable
7. Cover the cover plate of the device

Connect the device to the power supply, start the conveyor, and put an opaque object on the conveyor belt to check whether the X-ray works normally.

6.5 Changing and Adjusting X-ray Resource

When changing or adjusting the X-ray source, please follow the following step:

1. Cut the power supply of the system and disassemble the cover

-
2. Disconnect the cable of X-ray source
 3. Remove the fixing bolts of the X-ray source
 4. Remove the limited block
 5. Loosen the adjusting bolts
 6. Take out the X-ray source
 7. Install the new X-ray source according to the above steps
 8. Do not screw up the fixing bolt and the limited block
 9. Connect the device to the power supply
 10. Enter the “Menu” and then “Configuration”
 11. Adjust the adjusting bolts and handle on the right of X-ray source alternately to make the signal shown in the oscilloscope as high and even as possible.
 12. Screw up the fixing bolts and limited block of the X-ray source after the adjustment. Make sure you have not influenced the correct wave shown on the oscilloscope during the screwing.
 13. Cut the power supply of the system.

6.6 Preheating of X-ray Tube in X-ray Source

1. The purpose of preheating the X-ray tube

The purpose of preheating the X-ray tube is to decrease the failure rate of X-ray source, extend the useful life of X-ray tube, and enhance the reliability of the complete device. For MF X-ray source (including the X-ray source installed or uninstalled) that is used in X-ray security check system of line scanning, if it is not used for over half a year or it is transported or vibrated fiercely for some reasons, it is essential to preheat the X-ray tube according to the preheating procedures.

When the device is installed and tested on site or the device is restarted after a long time, it is essential to preheat the X-ray tube strictly.

2. The preheating procedure
 - (1) Electrifying
 - (2) Initial adjusting
 - (3) Preheating
 - (4) Final adjusting

6.7 Common Failure and the Maintenance

This chapter gives the probable failure phenomenon, reasons, and the solutions.

Before maintaining, please read the above chapters carefully.

For maintenance, please use the parts and spare parts manufactured by our company and offered for the specific conditions only.

Any device failure caused by non-authorized maintenance or damage caused by using other parts instead of the parts of the company, the company will not take any responsibility.

We reaffirm that all maintenance and adjustment are done by qualified maintainer. The device should be connected to the power supply only when all circuit boards are inserted properly. Please note that you should cut the power supply when you are drawing or inserting the printed boards. The following chapters show the reasons and the solutions in classified failures based on the failure phenomenon.

6.7.1 Power Supply

Failure 1: The system cannot be electrified.

Probable reasons:

- (1) The power supply is not correct.
- (2) There is no key switch or the key switch is not switched on.
- (3) The fuse is broken.
- (4) The circuit breaker is open.
- (5) Emergency stop button is in locking status.
- (6) The AC contactor is broken.
- (7) The connection of terminals is loosened.

Solutions:

- (1) Check the local power supply, and make sure it is $220+10\% /-15\%$ V, and 50 ± 3 Hz
- (2) Insert the key switch and rotate it clockwise to the switch on position.
- (3) Change for a new fuse.
- (4) Close the circuit breaker.
- (5) Reset by revolving the emergency stop button clockwise.
- (6) Change the AC contactor.
- (7) Check the connection and reconnect the line.

Note: Make sure the device works normally before electrifying the system.

Failure 2: The power supply indicator does not light.

Probable reasons:

- (1) The device has not started.

-
- (2) The cable of indicator is not connected.
 - (3) The connection of terminals is loosened.
 - (4) The indicator is broken.

Solutions:

- (1) Start the device.
- (2) Connect the cable of the indicator.
- (3) Check the connection and reconnect the line.
- (4) Change the indicator.

Failure 3: The system cannot be electrified, but with no other functions.

Probable reasons:

- (1) The power supply of electronic controller or X-ray source controller is not connected.
- (2) Contactor KM2 is broken.
- (3) The switching power supply is broken.
- (4) Network is not connected.
- (5) The serial port cable that connected to the industrial control computer is not connected.

Solutions:

- (1) Insert the plug of electronic controller or X-ray source controller into the corresponding sockets.
- (2) Change the contactor.
- (3) Change the switching power supply.
- (4) Connect the network to the industrial control computer.
- (5) Connect the serial port cable to the industrial control computer.

Note: Incorrect voltage output may damage the parts of device. Cut the power supply when changing or adjusting the parts.

6.7.2 System Control

Failure 1: The conveyor does not run functionally.

Probable reasons:

- (1) RS232 line is not connected.
- (2) The electronic controller is broken.
- (3) The starting capacitor is broken.
- (4) The cable connection is loosened.
- (5) The driving roller is broken.

(6) The conveyor belt is blocked.

Solutions:

- (1) Connect the RS232 line properly.
- (2) Change the electronic controller.
- (3) Change the starting capacitor.
- (4) Check the connection and tighten the cable again.
- (5) Change the driving roller.
- (6) Adjust the conveyor belt.

Failure 2: The conveyor belt does not stop.

Probable reasons:

- (1) The electronic controller is broken.
- (2) CPU board failure

Solutions:

- (1) Change the electronic controller.
- (2) Restart the industrial control computer.

6.7.3 X-ray Control

Before maintaining this part, please eliminate all failures that related to power supply and system control.

There are two kinds of failures concerning the X-ray control.

Failure 1: X-ray source does not emit X-ray

Probable reasons:

- (1) There are no articles in the tunnel, or the articles have not blocked the photoelectric sensor.
- (2) The cover plate on which the interlock switch is installed is open.
- (3) The power plug of X-ray source controller is not inserted in the socket.
- (4) The AC contactor is broken.
- (5) The X-ray source is broken.
- (6) The X-ray source controller is broken.
- (7) The cable of X-ray source is not properly connected.
- (8) The photoelectric sensor is not properly connected.
- (9) The photoelectric sensor is broken.
- (10) The driving roller has not started.
- (11) The electronic controller is broken.

Solutions:

- (1) Put large and light-tight articles in the tunnel.
- (2) Cover the cover plate in the position of interlock switch.
- (3) Plug in the power plug of X-ray source controller.
- (4) Change the AC contactor KM2.
- (5) Change the X-ray source.
- (6) Change the X-ray source controller.
- (7) Reconnect the cable of X-ray source.
- (8) Check the cable of photoelectric sensor and connect it correctly.
- (9) Change the photoelectric sensor.
- (10) Start the driving roller.
- (11) Change the electronic controller.

Failure 2: The X-ray indicator does not light

Probable reasons:

- (1) X-ray has not emitted.
- (2) Electronic control panel is broken.
- (3) The cable is not properly connected.
- (4) The indicator is broken.

Solutions:

- (1) Put the articles on the conveyor belt, and start the roller to emit the X-ray
- (2) Change the electronic control panel
- (3) Check the cable and connect it correctly
- (4) Change the indicator

6.7.4 Image Display

Before image system searching the failure, make sure the electric and machinery part of the X-ray generator are properly adjusted. Make sure the power supply of system meets the requirement (5V, $\pm 5\%$; 12V, $\pm 10\%$).

Failure 1: The display does not work when the system is electrified.

Probable reasons:

- (1) The power supply of display is not connected.
- (2) The signal line of display is not connected.

Solutions:

- (1) Connect the display to the power supply
- (2) Connect the signal line of display

Failure 3: The industrial control computer checks the program after starting up, but the display shows the vertical stripes.

Probable reasons:

- (1) Signal processing board
- (2) Connecting line

Solutions:

- (1) Change the signal processing board
- (2) Change the connecting line

Failure 4: There is no image during the luggage check.

Probable reasons:

- (1) The serial port connecting line between control panel and industrial control computer
- (2) Control panel
- (3) Photoelectric sensor

Solutions:

- (1) Change the serial port cable
- (2) Change the control panel
- (3) Change the photoelectric sensor

Failure 5: There appear horizontal lines during the luggage check. (It is normal to have three to six dark lines in the image, in which the conveyor belt has two dark lines.)

Probable reasons:

- (1) Detector or the detecting panel

Solutions:

- (1) Change the detector or the corresponding X-ray security inspection system is a high-tech combined mechanical and electrical products. Therefore, users not only to understand the technical characteristics of the machine, structure, principle and operation procedures, but also good at doing the daily maintenance and maintenance work, in order to give full play to its efficiency and extend the use fixed number of year, and to ensure that equipment and personal safety.

Chapter VII After-sales Service

7.1 Guarantee

We put technical support and after-sales service in the first place, and try to provide quality service for our customers.

7.2 After-sales Service

Thank you for choosing our devices. We have been providing offer high-class after-sales service.

The services include:

1. Choose the close appointed repair unit if you want to have a maintenance service.
2. If there is any question or difficulty in maintenance, please contact the local repair center.

The guarantee service is not applicable to the security check devices in one of the following conditions.

1. The trademark or the series number of the device or parts is torn or changed.
2. The device is damaged by improper use, maintenance, or storage.
3. The device is damaged by unavoidable force.
4. The device has been maintained by non-appointed repair unit or personally.
5. The device has been combined or assembled with devices from other companies, unless obtaining the written agreement of the company.

However, they can be repaired with some charge.

After-Sales List:

Company Name:		
Address:		
Contact:	Title:	Tel:
Equipment Model:	Number of units:	
Purchasing Time:		
Currently equipment failure phenomenon (detailed description):		

Date: